

MPC Systeemrails

sendzimir verzinkt

Toepassing

- Ideaal ook als draagconstructie voor luchtkanalen in droge binnenruimtes
- Veelvuldige montage mogelijkheden voor installaties en stellages in combinatie met de omvangrijke systeem-bouwdelen

Uw voordelen

- Snelle en rationele bevestiging van leidingstramien en leidingtraversen
- Maatvoeringsstrepen zijdelings en op de sleufkant vereenvoudigen de uitrichting van bevestigingselementen bij de installatie en vergemakkelijken het op maat maken van de profielen op de werkplek
- Voor veilige zijdelingse en hoogtever-stelbare bevestigingen
- Hoge buigvastheid door gunstige profieldwarsdoorsnede
- Voor de opbouw van statisch juist bemeten constructies door middel van veelvoud aan verbindingdelen
- Mooi optisch beeld door de toepassing van MPC-afsluitkappen

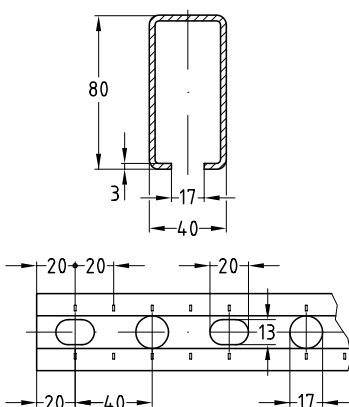

Profiel 40/80



De gegevens



Profiel	Lengte [mm]	Artikelnr.	Verp. eenheid	Eenheid
40/80/3,0	6.000	130024	1	Stuk

 Voor toepassingen in bereiken met eisen aan de brandweerstandsduur zijn de beperkingen in de brandpreventiebewijs te betrachten.

### MPC Systeemrails

#### Technische gegevens

#### Technische gegevens van de profielen:

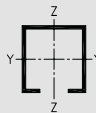
De gegevens										
Profiel	Materiaal	Oppervlakte	Toelaatbare staalspanning $\sigma_{toel.}$ [N/mm <sup>2</sup> ]	Verkrijgbare MPC Schuifmoeren	Profielgewicht [kg/m]	Profieldoorsnede [cm <sup>2</sup> ]	Traagheidsmoment		Weerstandsmoment	
							$I_y$ [cm <sup>4</sup> ]	$I_z$ [cm <sup>4</sup> ]	$W_y$ [cm <sup>3</sup> ]	$W_z$ [cm <sup>3</sup> ]
	DX51D	sendzimir verzinkt	153	M8, M10	0,6	0,69	0,2911	0,9554	0,31	0,707
					1,15	1,36	1,3999	2,0551	0,911	1,467
					1,21	1,4	1,0871	3,6213	0,905	1,905
					1,82	2,21	4,3286	6,1	2,164	3,21
					2,8	3,35	10,4472	9,7614	4,018	5,005
					3,5	4,44	17,5426	13,3946	5,847	6,697
				4,68	5,64	37,939	17,5106	9,484	8,755	
				38/48/1,75 H	2,43	2,79	6,1952	7,2427	2,581	3,811
				38/80/2,0 H	3,58	4,42	26,3479	12,2001	6,586	6,421
				40/120/3,0 H	7	8,88	115,0004	26,789	19,166	13,394

#### Belastingswaarden van de profielen voor buiging om de Y-as in [N]:

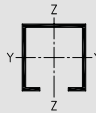
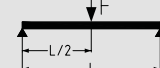
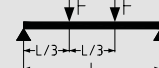
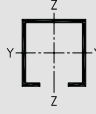
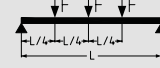
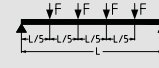
Profiel	L [m]						L [m]						
	0,5	1,0	1,5	2,0	4,0	6,0	0,5	1,0	1,5	2,0	4,0	6,0	
													
													27/18/1,25
	28/30/1,75	1.099	549	303	162	-	-	814	410	178	95	-	-
	38/24/1,75	1.094	541	233	122	-	-	812	317	136	72	-	-
	38/40/2,0	2.609	1.308	867	523	92	-	1.927	979	559	307	54	-
	39/52/2,5	4.830	2.430	1.612	1.198	260	43	3.555	1.816	1.206	752	153	25
	40/60/3,0	7.019	3.537	2.349	1.748	467	117	5.157	2.643	1.758	1.272	274	69
	40/80/3,0	11.311	5.733	3.815	2.844	1.080	359	8.246	4.274	2.852	2.128	634	211
	38/48/1,75 H	3.100	1.559	1.032	753	139	-	2.280	1.165	772	442	82	-
	38/80/2,0 H	7.834	3.977	2.646	1.971	741	235	5.696	2.962	1.977	1.475	435	138
40/120/3,0 H	22.447	11.542	7.711	5.765	2.785	1.353	16.040	8.554	5.749	4.307	2.026	794	
													
													27/18/1,25
	28/30/1,75	544	274	128	68	-	-	451	228	100	54	-	-
	38/24/1,75	542	228	98	52	-	-	450	179	77	41	-	-
	38/40/2,0	1.287	652	401	220	39	-	1.067	542	315	173	30	-
	39/52/2,5	2.374	1.210	804	540	110	18	1.965	1.006	670	424	86	14
	40/60/3,0	3.444	1.760	1.172	873	197	49	2.848	1.464	976	717	154	39
	40/80/3,0	5.508	2.847	1.901	1.420	455	151	4.541	2.365	1.582	1.182	357	119
	38/48/1,75 H	1.523	776	515	317	59	-	1.260	645	429	249	46	-
	38/80/2,0 H	3.804	1.973	1.318	984	312	99	3.133	1.639	1.097	819	245	78
40/120/3,0 H	10.711	5.697	3.833	2.873	1.391	570	8.763	4.723	3.186	2.391	1.141	447	

De technische gegevens gelden voor statisch rustende belastingen. Berekening op basis van de Eurocode (EC3).

Het veiligheidscoëfficiënt  $\gamma = 1,54$  houdt rekening met de veiligheids- en combinatiecoëfficiënten en met het veiligheidscoëfficiënt van het materiaal.

Bij de aangegeven waarden wordt de toelaatbare staalspanning volgens tabel en de maximaal toelaatbare doorbuiging  $L/200$  met inachtneming van het eigen gewicht niet overschreden.

### MPC Systeemrails

#### Technische gegevens

Toegelaten knikbelastingen voor profielen in [N]:

Kniklengte Lk [mm]	27/18/1,25	28/30/1,75	38/24/1,75	38/40/2,0	39/52/2,5	40/60/3,0	40/80/3,0	38/48/1,75 H	38/80/2,0 H	40/120/3,0 H
200	10.105	20.698	20.992	33.744	51.172	67.749	86.061	42.610	67.488	135.498
300	9.403	19.911	20.046	33.405	51.172	67.749	86.061	42.392	67.488	135.498
400	8.553	19.069	19.000	32.478	50.269	66.660	84.785	41.299	66.644	134.144
500	7.531	18.133	17.798	31.508	49.109	65.155	82.904	40.166	65.642	132.242
600	6.416	17.068	16.404	30.469	47.902	63.593	80.954	38.964	64.571	130.223
700	5.355	15.861	14.839	29.338	46.627	61.946	78.904	37.669	63.403	128.040
800	4.444	14.529	13.190	28.095	45.264	60.190	76.721	36.258	62.104	125.636
900	3.705	13.132	11.582	26.730	43.794	58.302	74.378	34.714	60.639	122.951
1.000	3.116	11.749	10.109	25.245	42.206	56.263	71.852	33.033	58.966	119.914
1.100	2.648	10.451	8.818	23.663	40.491	54.064	69.128	31.226	57.046	116.455
1.200	2.273	9.278	7.713	22.023	38.654	51.706	66.208	29.323	54.851	112.513
1.300	1.970	8.243	6.778	20.374	36.712	49.209	63.109	27.368	52.374	108.052
1.400	1.722	7.343	5.987	18.765	34.696	46.605	59.869	25.417	49.641	103.084
1.500	1.517	6.565	5.318	17.237	32.643	43.942	56.545	23.518	46.719	97.686
1.600	1.346	5.893	4.750	15.813	30.597	41.274	53.199	21.712	43.703	91.997
1.700	1.203	5.312	4.265	14.506	28.599	38.652	49.897	20.023	40.692	86.189
1.800	1.080	4.809	3.848	13.317	26.680	36.121	46.695	18.463	37.772	80.436
1.900	976	4.370	3.488	12.244	24.864	33.712	43.636	17.037	35.004	74.879
2.000	886	3.987	3.176	11.278	23.163	31.448	40.748	15.740	32.423	69.614
2.100	807	3.651	2.902	10.409	21.584	29.336	38.047	14.563	30.042	64.696
2.200	739	3.355	2.663	9.628	20.126	27.380	35.539	13.499	27.862	60.148
2.300	679	3.092	2.451	8.925	18.784	25.576	33.219	12.536	25.874	55.968
2.400	626	2.859	2.263	8.292	17.553	23.916	31.082	11.664	24.065	52.141
2.500	579	2.651	2.096	7.720	16.425	22.392	29.115	10.874	22.421	48.645
2.600	537	2.464	1.947	7.203	15.391	20.993	27.308	10.157	20.927	45.454
2.700	499	2.297	1.813	6.735	14.443	19.709	25.647	9.506	19.567	42.540
2.800	465	2.145	1.692	6.309	13.574	18.530	24.121	8.912	18.328	39.879
2.900	435	2.008	1.583	5.921	12.776	17.447	22.718	8.371	17.198	37.446
3.000	407	1.884	1.484	5.567	12.043	16.451	21.425	7.875	16.165	35.217
3.100	382	1.771	1.394	5.243	11.368	15.533	20.234	7.422	15.219	33.174
3.200	359	1.667	1.312	4.946	10.746	14.686	19.135	7.005	14.351	31.297
3.300	339	1.573	1.237	4.674	10.172	13.904	18.120	6.622	13.553	29.569
3.400	320	1.486	1.168	4.422	9.641	13.181	17.180	6.269	12.819	27.977
3.500	302	1.406	1.105	4.191	9.149	12.511	16.309	5.943	12.142	26.507
3.600	286	1.332	1.047	3.977	8.693	11.890	15.501	5.641	11.516	25.148
3.700	271	1.264	993	3.778	8.270	11.312	14.750	5.362	10.936	23.888
3.800	257	1.202	943	3.594	7.876	10.775	14.051	5.102	10.398	22.719
3.900	245	1.143	897	3.423	7.509	10.274	13.399	4.861	9.899	21.632
4.000	233	1.089	854	3.264	7.167	9.807	12.791	4.636	9.434	20.621
4.100	222	1.038	815	3.116	6.847	9.370	12.222	4.426	9.001	19.678
4.200	212	991	777	2.977	6.548	8.962	11.690	4.230	8.597	18.797
4.300	202	948	743	2.847	6.268	8.579	11.192	4.047	8.219	17.974
4.400	193	906	710	2.726	6.005	8.220	10.724	3.875	7.865	17.203
4.500	185	868	680	2.612	5.758	7.883	10.285	3.714	7.534	16.480
4.600	177	832	652	2.505	5.526	7.565	9.872	3.563	7.223	15.801
4.700	170	798	625	2.405	5.308	7.267	9.483	3.421	6.930	15.163
4.800	163	766	600	2.310	5.102	6.986	9.116	3.287	6.655	14.563
4.900	157	736	576	2.221	4.908	6.720	8.770	3.160	6.396	13.998
5.000	151	708	554	2.137	4.724	6.469	8.443	3.041	6.152	13.464
5.100	145	681	533	2.058	4.551	6.232	8.134	2.928	5.921	12.961
5.200	139	656	513	1.983	4.387	6.008	7.841	2.822	5.703	12.485
5.300	134	632	495	1.912	4.231	5.795	7.564	2.721	5.497	12.034
5.400	129	610	477	1.844	4.084	5.594	7.302	2.626	5.302	11.608
5.500	125	588	460	1.780	3.944	5.403	7.052	2.535	5.117	11.203
5.600	121	568	444	1.720	3.812	5.221	6.815	2.449	4.941	10.819
5.700	116	549	429	1.662	3.685	5.048	6.590	2.367	4.775	10.455
5.800	112	531	415	1.608	3.565	4.884	6.376	2.290	4.616	10.109
5.900	109	513	401	1.556	3.451	4.727	6.172	2.216	4.465	9.779
6.000	105	497	388	1.506	3.342	4.578	5.977	2.145	4.322	9.466

### MPC Systemrails

#### Technische gegevens



Knikbelastingen volgens DIN EN 1993-1-1 paragrafen 6.2 en 6.3.

De tabelwaarden gelden voor vol dragende dwarsdoorsneden en gecentreerde belasting.

De mogelijke geringere slankheidsgraad voor torsieknik en buigtorsieknik moet apart onderzocht worden!

Knikbewegingen om de z- en y-as werden onderzocht.

De ongunstigste knikbelasting is in de tabel opgenomen.

Het veiligheidscoëfficiënt  $\gamma = 1,54$  houdt rekening met de veiligheids- en combinatiecoëfficiënten en met het veiligheidscoëfficiënt van het materiaal.

Afhankelijk van de opslagcondities en de staaf lengte  $l$  in overeenstemming met de afbeelding de maatgevende kniklengte  $L_k$  bepalen.

Met  $L_k$  in de tabel de knikbelasting  $F$  aflezen.

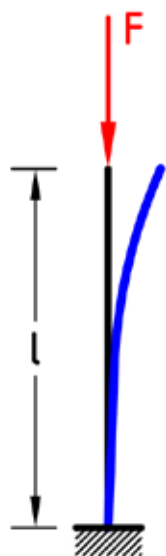

$$L_k = 2,0 \times l$$

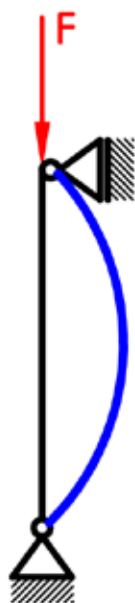

$$L_k = 1,0 \times l$$

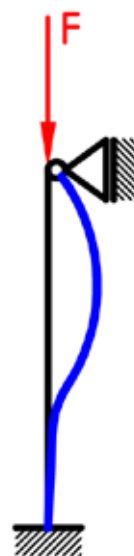

$$L_k = 0,7 \times l$$



$$L_k = 0,5 \times l$$